

USED ON	SCALE 1:1	TITLE SF56 Acrylic Screw On Level	DRAWING NUMBER SF56		
---------	--------------	--------------------------------------	------------------------	--	--

ISSUE	AMENDMENT	DATE
-------	-----------	------

Note :
Vial sensitivity : 30 minutes per 2mm bubble movement

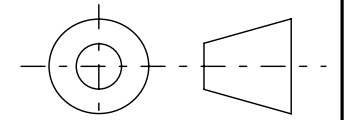
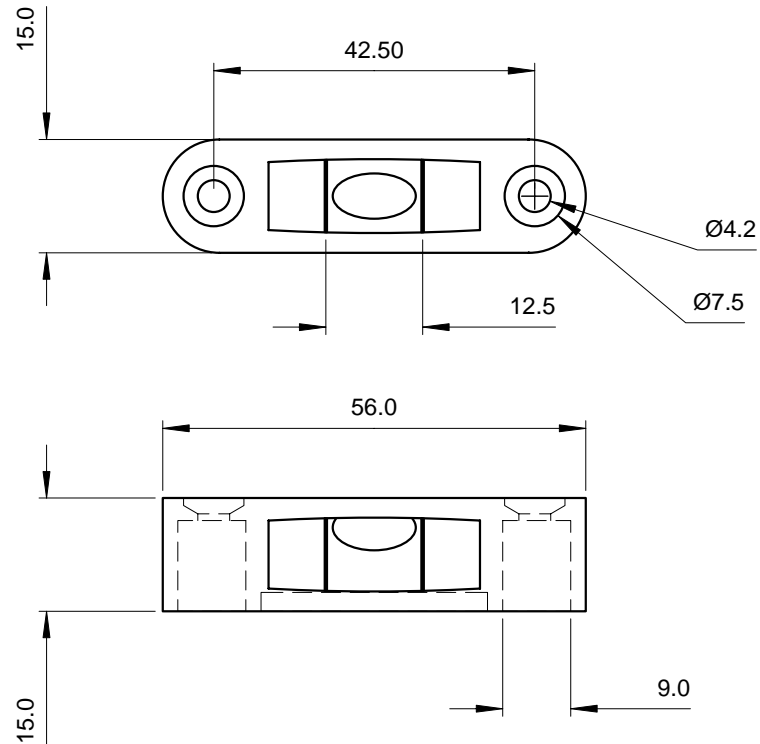

Third Angle Projection

FINISH	TOLERANCES UNLESS STATED OTHERWISE mm UNITS	XX. +/- 1.0 XX.X +/- 0.25 XX.XX +/- 0.1	MATERIAL Acrylic block with hydrocarbon fluid	DRAWN BY J.H.L	DATE 23/12/2004	LEVEL DEVELOPMENTS Croydon, Surrey, CRO 2DN